

LEUCOline

H I G H L I G H T S 2 0 1 5

**GOOD
IDEAS
NEED**
...

... **GOOD
SOLUTIONS**

TABLE OF CONTENTS

2 STATIONARY PROCESSING

Perfect use of the 5th axis!
Roughing, Finishing, Nesting & Co.

5 NON WOOD PROCESSING

Solid surface, Aluminum Composite Materials
Sawing, jointing & drilling

8 LOW NOISE SAWING BY „LEUCO nn-SYSTEM“

Experts report about their experiences
Sizing and Panel sizing

12 THROUGH-FEED PROCESSING

High-End edges with invisible glue joint
Jointing with exchangeable cutting edge inserts

14 EFFICIENCY BY TOOLS

Each degree of shear angle counts!
Profitable with 70° tools

16 SOLID WOOD PROCESSING

New, high precise cutter head clamping
Planing with coated knives

18 SERVICES

LEUCO's service logistics concept
Leasing of tools – a customer reports

20 TOOLMANAGEMENT

LEUCO Study: „Industry 4.0“ for tools
Toolmanagement concept based on a chip

22 NEW! LEUCO ONLINE-CATALOG

Find your tools easy on
www.leuco.com!



LEUCO Solutions

CNC PROCESSING WITH 5-AXES

UPGRADE
YOUR
APPLICATIONS

RAZOR-SHARP AND IN CONTINUOUS USAGE

The Ruhsi company in Baden's Rheinbischofsheim/Germany manufactures tabletops in all sizes, shapes, surface designs and edge variations. That creates diversity. Around one million different tabletop desi-



Tirelessly in use: LEUCO p-System cutter at Ruhsi GmbH

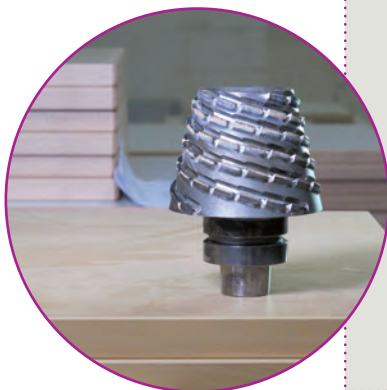

LEUCO P-SYSTEM TOOLS WITH MULTIFACETED TALENTS

gns, which could theoretically be requested every day, are thus defined in the system. Highly flexible and extremely efficient production is essential for the success of such an organization. Ruhsi counts on the performance of the LEUCO p-System milling tool with its 70° shear angle in both continuous and stationary machining operations.

The first LEUCO p-System milling tool was thus installed in 2010 on a CNC router for the formatting of tabletops, including veneered panels. Cracks on the edges used to occur repeatedly, particularly on oak veneer. The p-System was able to reduce the number of cracks to zero, even for transverse machining. In terms of efficiency, the tool is an asset here: The number of rejects is considerably smaller and much less post-processing is needed, which would inhibit the throughput of the workpieces.

Ruhsi invested in a new continuous processing system in 2011 and equipped it from the very beginning with powerful LEUCO p-System tools for finish milling of the edges. They join the final millimeter before the edge is glued on. Ruhsi uses the jointing cutter to create a razor-sharp edge and thus the condition for a top-quality glued joint.



„Both machine and tool manufacturers need to have understanding of the problems at hand. With LEUCO we have a partner that has proven able to do this.“ Michael Neuburger, Technical Manager, Ruhsi GmbH

Two different p-System milling tools are used in the latest investment, a machining center with a 5-axe spindle and two different gluing units. The first milling tool provides an outstanding edge in the sizing of the workpiece. The second LEUCO p-System milling tool is not only equipped with the LEUCO patented 70° shear angle, but also has the shape of a flat point. It cuts the diagonal sections in just two work steps without leaving any traces behind. The flattest section is 12° and can be graded however desired. The milling tool is

Even modern 5-axis machining centers can come to their limits. If very flat bevels have to be milled on large panels one must pay attention. There is the risk that the 5-axis head at maximum swung-out state could collide with the interfering contour of the component.

LEUCO SOLUTION - THE TRUNCATED-CONE SHAPED LEUCO P-SYSTEM CUTTER

- | Short length, so that the dust hood can be entirely closed
- | Lightweight and stable at the same time, so that the permitted tool weight of the 5-axis machine does not get exceeded but the cutting quality nevertheless meets the high demand
- | Machine complicated elliptical toolpaths as well as simple flats.
- | Excellent cutting quality, so there is only little need left for additional sanding.
- | The aim of finishing the work on one machine must be guaranteed, so that there is no additional manual rework required

For above reasons a LEUCO p-System solution with 70° shear angle serving as a "base" was a must. This patented principle was transferred to a conical basic shape.

IN
DETAIL

More about p-System
with Ruhsi on the LEUCO
YouTube-Channel



unique worldwide and ideally designed for the now widespread 5-axle technology. The compact tool can be used to machine comparatively broad surfaces, is proportionally lightweight, flexible to program, and perfectly sized for small suction hoods. The globally unique cutter was jointly developed by Ruhsi, the machine manufacturer, and the LEUCO research & development experts. Ruhsi can use the cutter for conventional milling of the workpiece without leaving any cracks, even with veneered edges. Ruhsi is thus able to completely process tabletops with diagonal sections on the CNC machine. And why the tool is profitable for Ruhsi on top of everything else – it doesn't need sharpening until after nine months of continuous usage.

RUHSI COMPANY PROFILE:

Founded in 1949, meanwhile produces 100,000 tabletops annually with around 50 employees in a 7500 m² facility with an innovative, highly automated machine pool and state-of-the-art control systems.



Beveled edge with 12° on the machining center in just two work steps without cracks on the veneered edge.

Ruhsi has therefore achieved its goal – complete processing with as many steps as possible being completed at a single station. Simply flexible and profitable.

... MAKE USE
OF YOUR
POTENTIAL!

„LAMELLO CLAMEX P“ WOOD JOINER JOINTING ...

LEUCO takes advantage of a 5-axis effect for a clever solution

... ON 5-AXIS-CNC WITH A SHANK-TYPE CUTTER

Additional to the grooving cutter with diameter 100.4 mm for the CNC there is a completely new and quite clever solution to do the jointing for Lamello Clamex P wood joiners.

This HW tipped shank-type cutter is suitable especially for inboard placed grooves, in case they can not be done by the standard Lamello Clamex P cutterhead.

Simple and clever and the same time!
The new shank-type cutter for jointing of
Lamello Clamex P profile grooves of LEUCO.

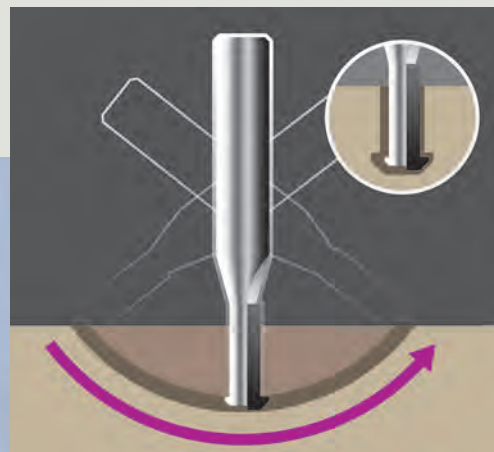



LEUCO Solutions

LEUCO SOLUTIONS FOR CNC-MACHINING WITH 5 AXES



EXTRA-LONG CLAMPING DEVICES INSTEAD OF EXTRA-LONG TOOLS!

Often 5-axes milling applications on hard-to-reach workpiece areas require long resp. extra-long shank-type tools. In order to minimize the risk of breakage those tools have to be made from heavy metal or solid tungsten carbide, thus resulting in corresponding lead times and higher tool costs.

LEUCO offers a whole range of smart alternatives: Extra-long collet chuck systems (up to A=225 mm), long heat shrink chucks (A=160 mm), heat-shrink extensions (A=up to 250 mm) or TRIBOS extensions (A=160 mm) allow the use of standard solid carbide or PCD tools for precise and safe routing of moldings with deep cavity and 5-axis applications.



Smart alternatives from LEUCO: Extra-long collet chuck systems (up to A=225 mm) and TRIBOS extensions.

WELL ROUNDED

The application areas for radius or spherical cutters are versatile. Profile grooves, contour milling, face milling in 3D applications, handrails in stair manufacturing, wave profiles on furniture parts or in wall panels are just a few examples.

Depending on the material to be machined and the batch size to be manufactured tools with different cutting edge materials are available.

An extensive standard range of 2- or 3-wing solid carbide shank-type cutters (R = 1.5 to 10 mm) covers a large part of the demand of the CNC user. The spherical cutter (R = 32.5) with TC inserts convinces with its high chip removal volume and the easy change of knives when it comes to moulding applications resp. shaping and contour milling of solid wood and wood-based materials. Longest edge- and tool-life even in abrasive materials can be achieved with the diamond-tipped radius cutters. Tools with R = 10, 15 or 20 mm are available ex stock.



Profile grooves, contour milling, face milling in 3D applications, handrails in stair manufacturing, wave profiles on furniture parts or in wall panels are just a few examples for use the radius cutters.

SHARP AND POINTY!

Corner thinning, edge chamfering, folding cuts in wood-based materials or aluminum composite panels, decorative grooves or even trendy image engravings in light-reflex technique: LEUCO has the solution and of course the right tools for the particular application.

The TOK edge thinning cutter: no matter which material, whether veneered, laminated or coated with synthetic resin...

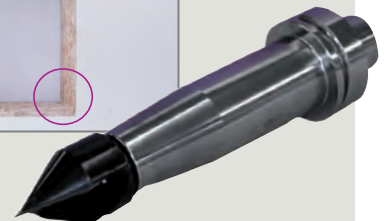

...the corners are cleanly cut without additional manual work required.



PCD Relief image shank-type cutter (90°) is the ideal tool to be used with the LettnerWorx "Pic2Plate" light-reflex technology software solution.

This technology is a computerized method to transfer image information onto panel materials by means of milling grooves with varying depths.



LEUCO Solutions

ROUGHING, FINISHING, NESTING AND JOINTING ON CNC

FROM COARSE TO FINE!



Roughing with diamond router bits? Why that? This question was asked by customers at LIGNA 2013. Tungsten, the raw material solid carbide spiral shank-type cutters are made, has become extremely expensive over the last years and thus prices for solid carbide roughing and finishing cutters have risen correspondingly strong.

Therefore can be worth to do a cost comparison with PCD-tipped tools.

In the last two years more and more customers machining solid wood, plywood, glued veneer, HPL compact panels, solid surface materials or composite materials have switched over and pre-cut the panels with PCD Roughing tools.

One step further at LIGNA 2015: The LEUCO PCD Roughing- and Finishing Cutter supplements the product range. High performance cutting with tear-free top- and bottom edges, thanks to the highly rigid body, alternating

shear angles, four wing design resulting in a very good cutting surface quality are the distinctive features of this new development.

You have the highest demands on an immaculate cut surface in laminated wood-based panels? Again, there is something new: the High-performance finishing router cutter Z = 4 + 4, PCD-tipped. As stable as his roughing brother, just even finer in result.



The powerful fine one: PCD Finishing shank-type cutter Ø16 x 32 mm, Z=4+4.



Convincing through performance: the new roughing-/finishing PCD cutter Ø16 x 32 mm, Z=2+2.

SIZING AND TRIMMING WITH P-SYSTEM TOOLS WITH SMALL DIAMETERS

The demand of our customers for LEUCO p-System shank-type tools with even smaller cutting diameters and the patented 70° shear angles can now be met.

The new p-System tools are available ex stock in diameters Ø12, Ø14 and Ø16 mm with different cut lengths as from LIGNA. Custom lengths are also feasible.



The new small-diameter tools now allow the milling of small internal radii in solid woods and wood-based materials with difficult to machine coatings in the proven p-System quality.

NESTING

The new highly stable diamond-tipped nesting cutter program from LEUCO meets the needs of the growing number of facilities that utilize the nesting procedure. Nesting is ideal for producing individual parts and small batch sizes on CNC stationary machines. High stability and balance quality give the new milling cutters very high operating smoothness. The advantages for users include a very long tool life, the best cut quality and low noise emission.

With the integration of the LEUCO „CM“ chip removal concept, the new milling cutters satisfy a key criteria: The chips are guided in the direction of the dust extraction, are optimally vacuumed away, double chip removal is avoided and heat development is reduced. The tool is subject to measurably less wear. The cutting quality on edges and middle layers is significantly better.

The jointing cutters with a negative spiral are ideal, particularly when nesting smaller and/or narrower workpieces, that tend to shift when processed on the CNC. The cutting pressure acts against the upper panel surface and pushes the workpiece towards the suction. The new DP high-performance range is avail-

able in diameters of 12 and 16 with cutting widths of 22 and 28 mm. The special base frame of the end mills, with a diameter of 12 mm, makes this dimension extremely stable. An additional optimization is yielded by the special arrangement of the blades and the company-developed chip gullet design.



Steps ahead!



LEUCO solution for processing „Non Wood“ materials

MACHINING OF COMPACT PANELS COMPLETE!

Long edge lives and chatter mark free edge surfaces

Solid core panels for indoor and outdoor areas are becoming increasingly popular. Specially designed LEUCO TCT or PCD saw blades to cut those long-lived and stable in value panel materials have been in our product program for quite long.

The new super-quiet „LEUCO nn System DP Flex blades“ are absolutely ideal for these materials, thanks to its special chip spaces and cutting edge geometry. Highest cutting quality and longest edgelif, in addition to the extreme noise reduction, are the major advantages of this new LEUCO specialty. The product range includes the most common dimensions for horizontal and vertical panel saws, table saws and CNC sawing units.

Tear-free holes on the entry and the exit side can be obtained with the proven LEUCO solid carbide „HP“ high performance drills without any problem and with extremely long edgelif.

Needless to say that all of the above mentioned tools are not limited to the machining of solid core materials only. Plenty of other hard, abrasive materials can be sized, shaped and profiled with those excellent products: HPL compact panels, façade panels, cement-fibre board products will be machined with them economically as well as MDF. The choice is all yours!

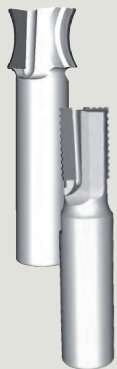
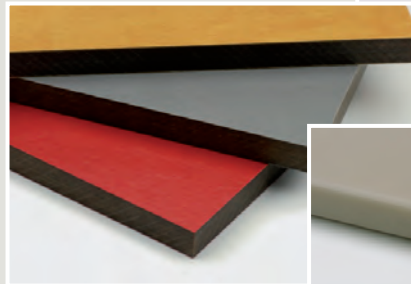

left: Fancy a drum profile on the edge? The new PCD-radius profile cutter provides panels with up to 14 mm with a radius $R = 16$ (Pic 3). And, if time is of essence: these tools are available ex stock from LEUCO in Horb/Germany.

right: Also a new product: swift pre-sizing of panels in roughing quality with the PCD roughing cutter Ø14x20 mm.

The already extensive range of straight edge PCD shank-type cutters with different diameters, cut lengths and cutting wings now got a further member: The Z=3 high-performance tool with a Ø12 mm diameter and 15 mm cut length for thinner panels.

PATENTED „GRILL“ AND „FACEPLATE“ VERSION



The „Aerotech System“ has been in the clamping element product portfolio at LEUCO for more than two years. It fulfills two functions on machining centers. Aerotech is both an innovative, highly precise clamping element and an extraction turbine.

As a result, the Aerotech System is an exceptional solution for dust-free grooving and cutting, with many advantages for the tool, the production, energy efficiency and health!

THE LEUCO AEROTECH PROGRAM IS BEING EXPANDED!

NEW:
AEROTECH
EXTENSION

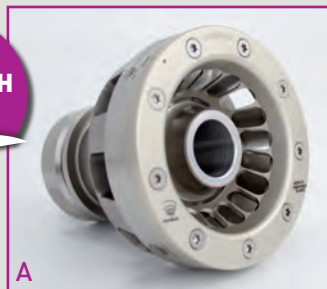

Particularly when nesting MDF and particle board, small remnants can occur which enter the turbine and clog it, or lead to an imbalance. The patented „HOMAG Grill“-Aerotech-Version ensures that no remnants settle in the turbine. At the same time, the grill reduces the background noise of the Aerotech. While the „Grill“ version is also exceptionally suited for processing on machines with console tables, the Aerotech „FacePlate“ version plays out its strengths particularly in purely nesting applications.

LEUCO solution for processing „Non Wood“ materials

ALUMINUM COMPOSITE MATERIALS

Sawing, milling and drilling with LEUCO tools

The possible uses of aluminum composite panels are very diverse: Facades for modern architecture, indoor and outdoor signs, store fronts, trade fair construction, shop construction, furniture design, displays, and so much more – familiar brand names include Alucobond, Dibond, Reynobond, Hylite etc. Panels made from two aluminum top sheets and one plastic or mineral core can be easily machined when the specific base materials are considered in the selection of your tools.

Sawing/trimming cut

Aluminum composite panels can be cut on horizontal and vertical panel saws and table saws.

Table saws with hard metal (HW) tips are generally used with triple chip/flat tooth geometry for burr-free edges. Large quantities or panels belonging to fire protection classification A1 can be cut efficiently by means of diamond-tipped saw blades.

The new extremely low-noise diamond-tipped „LEUCO nn-System“ saw blade is best suited for sizing cuts in aluminum composite material. Despite a cutting width of just 2.5 mm, it is suitable for continuous usage in single panel sizing cuts.



The diamond-tipped 135° or 90° V-groove cutters are used to notch panels with mineral, fire-retardant or plastic cores on the machining center.

The cutting of V-grooves

LEUCO V-groove profile cutterheads with anodized aluminum body are tools with consistent cutting circles. They guarantee simple handling thanks to quick knife change. They are used on vertical panel sizing saws.

The special tooth geometry of DP shank-type tools on CNC machines provides excellent cutting surfaces and very long edge lives particularly in abrasive wood-based panels with mineral cores.

Drilling

Spiral drill bits made from high speed steel (HS) with a sharp angle of 100° – 140° are suitable for drilling on aluminum composite materials with plastic cores.

HW drills such as those in the LEUCO Mosquito series achieve much longer edge lives with the best drilling quality in all types of panels (A1, B1, B2).

An additional alternative is the LEUCO full hard metal high performance drill (HL VHW) with particularly low cutting pressure. They are particularly recommended when the quality of the drill outlet side is particularly important along with the edge life.

The new innovative diamond-pointed „LEUCO nn-System“ saw blade with a cutting width of just 2.5 mm stands for high cutting quality, long edge lives and low noise during usage.

The LEUCO full hard metal high performance drill with its low cutting pressure is a good choice when the user also requires a high quality drill outlet side.



Steps ahead!



Aluminum composite materials are extremely versatile and can be used both outdoors, e.g. for facades, and for indoor construction.





Innovation

NEW: NN-SYSTEM SAW BLADES

The „No-Noise Saw Blades“

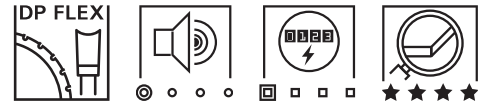
**DATA PROFILE NN-SYSTEM DP FLEX SAW BLADE**

The new "LEUCO nn-System DP Flex" saw blades all have ...	▶▶	... extremely small chip gullet spaces! And are extremely quiet when idling and during operation! With a noise level of just around 70 dB(A) when idling, the wearing of hearing protection is virtually a thing of the past.
They surprise the industry by their ...	▶▶	... usability in numerous materials
And impress their users by their ...	▶▶	... super cutting quality thanks to their special hollow back tooth configuration (HR); Exception: Scoring saw blades: WS tooth configuration
And to top it off, they are surprisingly thin! The ...	▶▶	... cutting width is a mere 2.5 mm
The blades generate noticeably ...	▶▶	... lower cutting pressure and therefore also require less power during usage
The edge lives are measurably ...	▶▶	... longer thanks to the diamond tips
Users profit from the "LEUCO nn-System DP FLEX" on ...	▶▶	... many types of machines such as table saws and chop saws, vertical panel sizing saws, CNCs and through-feed installations.

APPLIED
FOR
PATENT

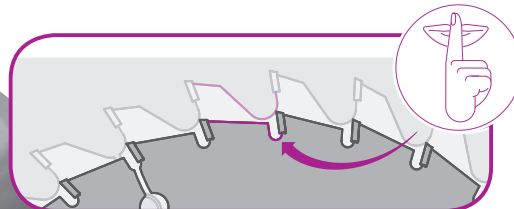
**THE NONOISE PRODUCT LINE AND ITS DIMENSIONS**

The NoNoise saw blades from LEUCO have a cutting width of just 2.5 mm and, with diameters of 260, 303 and 350 mm, can be used for final trimming saws, table saws, vertical panel sizing saws and soon to be available, even for miter saws in through-feed machines. They require their own splitting wedges, however, in widths between 2.0 and 2.4 mm. LEUCO is also announcing a version for the CNC with a diameter of 180 mm. In line

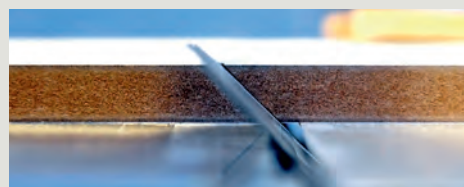

with the main saw blades, the diamond-tipped scoring saw blades with 120 and 125 mm diameters and conical alternate top bevel teeth are also available for two-sided crack-free cuts. Their equally small clamping spaces also ensure a low noise level. The Diamax teeth have a re-sharpening zone of 7/10 mm and can be resharpened twice. No sharpening service, however, can perform the re-sharpening at this time. LEUCO does that itself to maintain the tooth geometry for clean cuts.

Wolfgang Rüter

No slipping or splintering – not even when the saw blade is tilted.



An intimate relationship: Nico Albrecht and his NoNoise saw blade.



Nico Albrecht cuts samples with the nn-system saw blade.

ON LOCATION

IT MAY NOT BE GOLD-PLATED...

The No Noise blades in use at Werk33

Every two carpenters in Werk33 have one thing in common and they guard it with their lives: the „NoNoise“ saw blade. They use it to achieve outstanding cuts at the first go in every material imaginable. They can even get by without hearing protection.

The first impuls was given by the employees after their visit to the Holz-Handwerk (Wood crafts) 2014 trade show in Nuremberg. Werk33 in Enzweihingen, the carpenter's workshop located around 15 miles from Stuttgart, which has made a name for itself as a producer of high-quality trade show, furniture and interior design and also acts as a partner workshop, has been using the LEUCO no-noise or nn-System DP-Flex saw blades since the summer of 2014. The two company managers Stephan Leverberg and Rainer Faass, who founded the plant in 2007, are always happy to send their employees to trade shows. The carpenter shop meanwhile employs 70 workers. The staff alone includes 17 master carpenters and wood technicians. Their job is to look around at the trade shows and gather information. After visiting the Holz-Handwerk, they were thus able to convince Stephan Leverberg to purchase the LEU-

CO No-Noise saw blade, which at that time was a novelty on the market.

It cuts like butter

Production Head Christoph Metzger purchased three units immediately and entrusted one specimen to each of the two employees. They are thrilled by the cutting quality achieved with these new saw blades. They hadn't even come close to such results with the former saw blades. They now achieve clean miter cuts straightaway without any cracks on the panel undersides. Multiplex boards are cut through like butter and even mineral materials and Alucobond® panels can be excellently cut. The coworkers are also pleased that they no longer need to wear hearing protection for every cut. With this saw blade, the machine can barely be heard when it is idling. And even under load, it still always remains very quiet and above all not shrill.

But how efficient is the NoNoise saw blade?

Interested carpenters must ask this question as well. The procurement costs are around five times that of a good hard-metal saw blade. The considerably longer edge life of the diamond-tipped saw

blades allow them to be used 15-20 times more often before they need to be resharpened. In addition to this, the cuts are particularly precise and do not require any subsequent work. This alone already makes the blade more economical, says Christoph Metzger.

His employees do not want to give up their No-Noise saw blades in any case. On the basis of this experience, Stephan Leverberg and Rainer Faass are already thinking about purchasing additional saw blades of this new generation. A tool which employees guard with their lives must certainly be something very special. The NoNoise saw blade may not be gold-plated, but it has extraordinary features. The secret of the hollow back „The design ensures“, says Markus Erkenbrecher, the product manager for saws at LEUCO, „an excellent cutting quality for nearly all wooden panels, even those with high-gloss coatings and those made from solid timber“. LEUCO refers to the diamond teeth used here as „Diamax“. They have a hollow back tooth geometry. This is ultimately crucial to the excellent cutting quality. In addition to this, the hollow back tooth noticeably reduces the cutting pressure while enabling work with nearly no backlash.

Hearing protection is unnecessary

With the very small clamping frames, barely any perceivable noises can be heard when idling at a noise level of around 70 dB(A), which is 6 dB(A) lower than that of LEUCO's former quietest „G5“ and 13 dB(A) lower than with a standard panel saw blade. No shrill noises occur during load operation, but rather less stressful frequency oscillations. As explained by Markus Erkenbrecher, this makes it practically unnecessary to wear hearing protection.

Text excerpts, the original report was published in the dds magazine 2015



The nn-system saw blade (shown on the left) does not allow any melamine coatings to flake off, ...

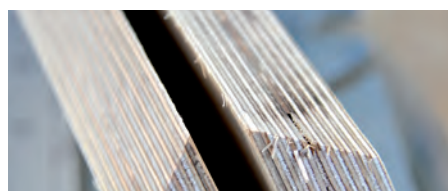

... or any long planks or crossbeams to fray on the trailing and bottom edges;

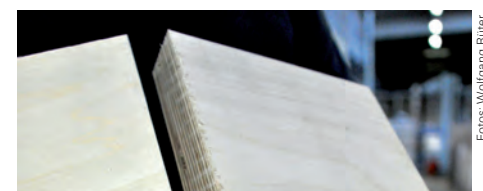

the cutting results with the old conventional saw blades are shown on the right.



Students tests panel sizing saw blade „LEUCO nn-System DP Panel“

NOISE LEVEL HALVED AT PANEL SIZING SAW

FHM Uses Innovative LEUCO Cutting Technology

We are 24 first semester students at the Technical College for Wood Technology in Melle (FHM). We all had vocational training in the field of wood technology and in some cases have many years' professional experience. Fortunately, we find a balanced mixture of theory and practice at the FHM.

So, in the last few weeks we have been working on the subject "Noise at Workplaces". Media keep on tackling this subject time and again, and we also have heard a thing or two in this connection when we visited the "HOLZ-HANDWERK Nuremberg 2014" exhibition, the European Trade Fair for Machine Technology, Equipment and Supplies for the Wood Crafts. We initially informed ourselves at the tool manufacturers', but there are also chapters on "Sound Pressure Levels" in the technical literature, limit values of 85 dB(A) and theories that halving the measured values does not mean halving the noise, but reducing noise by 6 dB(A) represents a perceived cutting the noise to 50 %. For this reason, LEUCO presented us a newly developed, diamond-tipped panel sizing saw blade. This saw blade was said to be quieter than all hitherto existing DP saw blades for panel sizing saws due to smaller chip gullets.

Reason enough for us at this point to make a mark to theory and proceed to the project phase with the LEUCO saw blade. FHM invested in a sound level meter on the initiative of Senior Assistant Master (OSTr) Roland Cramer. Equipped with the brand-new instrument, we went to our training workshop to be on the noise track.

Sensitized After 50 Measurements

FHM is equipped with a "Holzma HPP380". Two diamond-tipped LEUCO saw blades were ready for noise level comparison: The new so-called "No-Noise-System" saw blade with small chip gullets that was said to reduce the noise by 6 dB(A) and the LEUCO diamond-tipped preceding model with its larger chip gullets. Will the smaller chip gullets clog faster and then im-

pair cutting quality? The tests were performed using a two-sided melamine-coated 19 mm particle board, a raw 19 mm MDF panel and a 19 mm Rauvisio Crystal panel. We had these 19 mm Rauvisio Crystal panels for test series on the premises within the scope of a technical thesis with REHAU in implementing stationary and through-feed technology. We took this opportunity to gain instant experiences with this new material and novel tool technology. These panels have a wood-based carrier panel which is coated with 2.5 mm plastic on both sides. The surface view is a 2 mm transparent acrylate (PMMA) creating the desired "glass optics look", but can still be machined with woodworking tools. However, this top layer is not easy to process due to its hardness and brittleness.

We performed noise level measurements at a distance of about 1 meter to the machine and examined the cutting qualities. We were exactly sensitized after some 50 measurements: How 73 dB(A) "sound" at idle, how 78 dB(A) sound, how annoying are 96.5 dB(A) on average, how pleasant are 89.2 dB(A) in contrast, etc. We calculated from the measurements one average value each per material and stack height. The blade with the smaller chip gullets was always quieter. The difference to the preceding blade varied between 3 and 6 db(A), depending upon material and stacking height in each case.

The No-Noise saw blade cutting quality was rather better

Volume measurement in dB

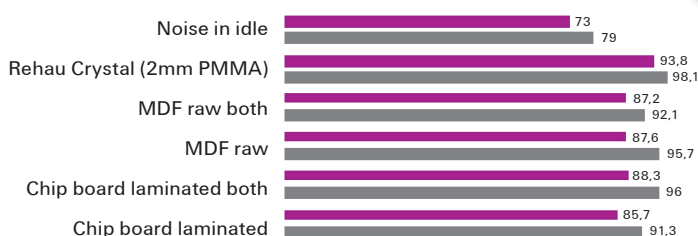

The results were summarized after more than 50 cuts.

Good ideas need good solutions.

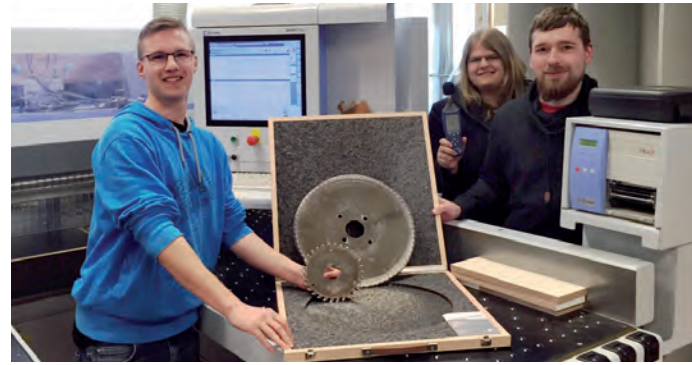

Michael Walkenhorst, Svenja Lulf and Mark Peukert (from left to right, students of FS Melle), compared the noise levels generated when trimming cutting different materials, stacking heights and cutting speeds using the traditional LEUCO diamond-tipped panel sizing saw blade and the LEUCO novel quiet, diamond-tipped "nn-System DP Panel" saw blade.

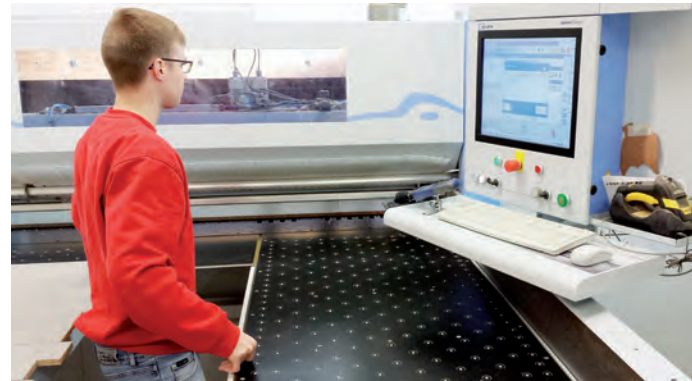

Tracking Noise! The noise level was measured at a distance of approx. 1 meter to the "noise source" and, hence, corresponds to the conditions which the machine operator is exposed to at the panel sizing saw.

than that one of the conventional reference saw blade during our tests. Statements on edge lives of these saw blades are still pending. Using this novel cutting technology has amazed us soon-to-be technicians and brought us "aha" experiences. The group's conclusion is: The performance of the novel saw blades remains good, but they are significantly quieter.

Quotations from the Project:

"In view of the fact that noise-induced hearing loss is at the top of occupational diseases in wood technology, halving of the noise level through innovative cutting technology represents a milestone in the history of noise protection. The physical consequences for the employees, such as reduced performance caused by high noise level and reduction of potential accident risk should not be underestimated."

"It is really fascinating to experience when the noise of the just installed extraction system drowns out the noise level of the saw blade at idle. LEUCO with its range of "No Noise" panel sizing saw blades makes it possible to halve the noise level."

THE PERFORMANCE OF THE NOVEL SAW BLADES REMAINS GOOD, BUT THEY ARE SIGNIFICANTLY QUIETER.

NO NOISE

LEUCO DIA „REFERENCE“

Efficiency

MORE THAN 100 METRES IN EVERY MINUTE

The LEUCO PowerTec III hogger combines high quality and high feed rates

The East –Westphalia kitchen manufacturer nobilia and a two-stage production concept.

2.600 kitchens are produced daily at nobilia's 2 production sites in Verl. Quality comes first, and not only for the individual doors, but at every single step of the production process. The cabinet production plays a central part – we are talking about efficient and fast production of standard parts "pre-hogging then finish jointing" this is the secret to success according to Mario Röttgers, head of parts production department at nobilia.

Pre-coated chipboards of 16mm and 19mm are machined by panel sizing sawblades, removing a gross mass of 4°mm to 5°. 3 mm is removed by the hogger (double hogging process with LEUCO PowerTec III), and the last millimetre is removed using the LEUCO p-

System jointing cutter. A 1.2 mm thick PP-edge (Polypropylene) is the decorative and protective edge finish.

A clean finished joint is not only an optical criteria: a good fitting of the edge is essential in protection against moisture, which is of course vital for kitchen furniture.

A special feature of the diamond tipped hogger "LEUCO PowerTec III" is that the pre-hogging cutting edge (positive hook angle) and the finish cutting edge (negative hook angle) are positioned on one wing. This allows twice as many cutting edges with the same diameter – up to 36 + 36, and therefore feed rates of up to 100 m/min. Standard parts have a feed rate of 80 m/min at nobilia. Nobilia offers customers fronts in sixteen different colours. Nobilia purchases a vast amount of chip-



The hogging cutting edge and the finish cutting edge are positioned on one wing on the LEUCO PowerTec III.

board, from different suppliers in different qualities – The Powertec III delivers a constant quality level.

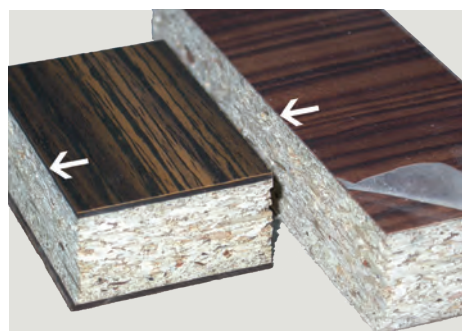

Clean edges: high gloss laminate machined with the LEUCO „PowerTec III topline LowNoise“! Even if its machined by using a protection foil.

HIGH-PERFORMANCE HOGGER

„PowerTec III topline“ henceforth on the low-noise trip

„Less noise while machining“ is the motto of the new „LEUCO PowerTec III topline LowNoise hogger“. The PowerTec hogger is used in double end tenoners with high feed rates. This hogger is recommended when perfect cutting quality and long tool life is in demand, for instance for use with hard and sensitive high-gloss materials. The cutter can be used starting with a workpiece thickness of 8 mm. The LEUCO PowerTec III topline hogger has been one of the most in-demand cutters on the market for a long time now.

The new design of the PowerTec tool body prevents air turbulence and noise emission is greatly reduced - up to 5 dB(A) when running idle and up to 2 dB(A) when in action. This makes work conditions significantly more comfortable. This



The LowNoise design is visible from first glance: The chip gullets and projecting edges are aerodynamically rounded and optimized with software computations.

makes the hogger the quietest in its class. The LowNoise design is visible from first glance. The chip gullets and projecting edges are aerodynamically rounded and optimized with software computations.

In the LEUCO tool development the improvement of the working environment has been an important part of the LEUCO development principles for quite some time. With a special pictogram on the hogsers LEUCO highlights the new era of PowerTec III Topline LowNoise hogsers, with its exemplary ratio of high performance and low noise level.

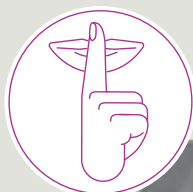



Joining cutter with exchangeable, diamond-studded segments

THE NEXT GENERATION: CHANGE SEGMENTS YOURSELF

SmartJointer becomes SmartJointer PLUS

The „LEUCO SmartJointer,“ with its diamond-tipped segments, has been an alternative to the brazed LEUCO-Diamax joining cutter for LEUCO customers for about three years. The choice is always made for the SmartJointer joining cutter when its „smart“ characteristics are desired, namely: lighter, quieter and conserving of resources.

The LEUCO SmartJointer...

The low weight of the SmartJointer is due to the high-tensile aluminum body. Dynamic processes such as jump-milling consume only a fraction of the previously required energy. Furthermore, the spindle bearings are under a reduced imbalance load. In addition, the light aluminum body vibrates less and creates less noise when at idle and during use. Together with the optimally designed, low knife protrusion, this leads to an audibly lower noise level on the jointer aggregate of the edge banding machine. The cutter is an exceptional addition to the „LEUCO Low-Noise“ joining cutter product line. Conserving resources and reusing the aluminum body as often as possible – SmartJointer users achieve this goal thanks to the LEUCO-specific segments with integrated steel chip gullets. As is well-known, the knives, followed by the chip gullets, are the areas of a cutting head which are most susceptible to

wear. The chip gullets on the SmartJointer are therefore simultaneously replaced during a segment change at the LEUCO ServiceCenter.

...becomes SmartJointer PLUS. The next generation of the DP cutter head.

Sharpening and replacing segments, with their integrated chip gullets, was previously exclusively carried out at the LEUCO ServiceCenter. In the SmartJointer PLUS, LEUCO has optimized the design of the segment seat. This now allows customers to change the diamond-tipped knives by themselves, with the greatest precision.

The Plus with the SmartJointer PLUS

Independent replacement of the segments provides users with a „new“ or „freshly sharpened“ tool directly and at any time – with the edge life of a diamond tool.

The LEUCO SmartJointer PLUS is ideal on edge banding machines, for jointing in jump-milling of melamine resin and paper-laminated HPL and foil-coated and veneered wood-based panels

In stock and now available...

the LEUCO SmartJointer PLUS for Brandt machines The entire previous SmartJointer product line will be converted to the „PLUS“ version in the future. Contact us!

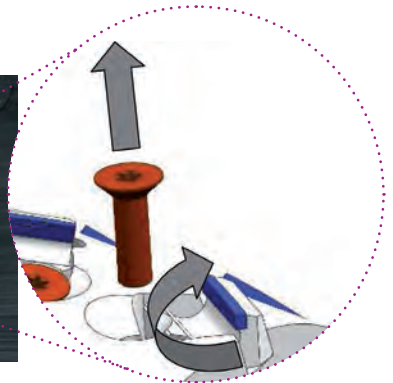

Change the segments by your own: You need only the diamond-tipped knives of LEUCO, a SmartJointer Plus body and a torque wrench.

LEUCO-specific segments with integrated steel chip gullets



HERE'S HOW IT WORKS:

New tool: LEUCO delivers the SmartJointer PLUS, segments are mounted and sharpened in the body. It conforms to the requirements/tolerances of a brazed joining cutter.

The joining cutter becomes partially dull: Generally one change of teeth rows is possible within a segment set. Teeth rows which process the cover layer and are already worn can be replaced with teeth rows from the middle layer. More edge life can be gained, depending on the joint quality requirements.

The segments are ready for resharpening:

Option 1: The user can change the segments in the SmartJointer PLUS themselves and send dulled segments to LEUCO Service for refurbishment. A high-quality, diamond-tipped cutter head is available to the customer for immediate use, without significant production downtime. Its precision meets the requirements of a cutter head.

Option 2: After reaching the end of its edge life, the tool is refurbished by LEUCO Service. The segments are sharpened in the body. The cutting quality is equivalent to that of a new tool.



Good ideas need good solutions.



For the invisible joint optics tear-free, razor-sharp joined edges are a must

„HIGH-END“ EDGE IN THE FURNITURE INDUSTRY

Holistic approach leads to the high precision tool solution

For the furniture manufacturers the issue zero joint is diverse. For several years, machine and edges manufacturers offer new methods, in which a heat source such as laser, plasma, hot air or infrared activates the functional layer of the edge band material and immediately glues it to the workpiece.

Regardless of the very process, for the invisible joint optics tear-free and razor-sharp joined edges are a must.

It is exactly this claim which the appropriate LEUCO tool solutions meet. Together with the furniture manufacturer LEUCO discusses individually every little detail and tailors the tools to the very situation.

The base: Analysis of material and machine
Which wood-based materials are used, what is the overlay of this material, what does the core of the panel look like, which material thicknesses are being processed? Which kind of edge is used? What is the configuration of the machine? Which and how many motor units are available for the joining process? What is the expected throughput? Which flexibility does the furniture manufacturer want to keep open?

Holistic tool solution for „high-end“ edges for through-feed jointing

LEUCO defines the machining sequence and the tool design such as cutting widths, cutting edge tip height and the application data exactly according to material and machine requirements – with the tear-free, razor-sharp joined edge -with maximum economic efficiency- in the focus, always. Therefore LEUCO recommends jointing cutter with a shear angle of 43° resp. 70°. The interface between the motor and tool affects the quality of the joint cutters. Therefore LEUCO strongly advises to pay close attention to the concentricity of tool clamping. Hydro or HSK toolholders ensure the most stable concentricity. A clean working environment contributes - particularly in the high-end range with microfine surfaces and tight tolerances at high feed speeds- to better quality. Tools with optimized chip flow design and an optimum suction prevent the so-called „multiple hogging“ which, among other things, may adversely affect the jointing quality and reduce the edgelife of the tools.

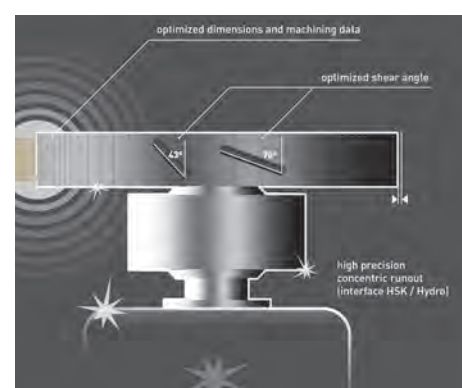
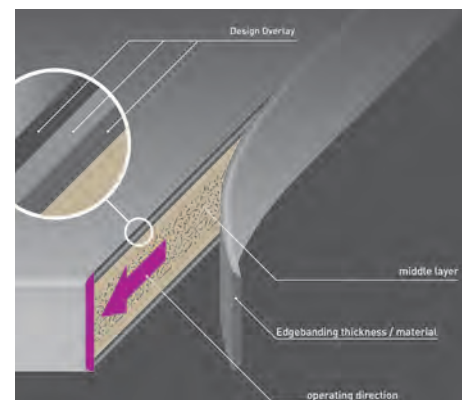

Anyone who wants the perfect homogeneous visual appearance in the high-end area needs a highly accurate and integrated tool solution on high-end level!

LEUCO Solution

BATCH SIZE 1 WITH ECONOMIC EFFICIENCY IN THROUGH-FEED MACHINING

Flexible multi-profile cutter for edge trimming

Customized edge designs with varying radiuses and chamfers on the workpieces and through-feed machining are not mutually exclusive. On the contrary. Producing batch size 1 on through-feed machines can be thoroughly technically and economically interesting. The machine and aggregate equipment and a flexible tool concept are decisive factors. For the „Batch size 1 on through-feed machines“ machining principle, LEUCO offers form cutters which allow up to four different profiles to be created with just one tool.

The „MFA“ and „KFA“ diamond-studded form cutting tools from LEUCO, for example, have been designed for systems from IMA. Each customer individually determines the three different radiuses and one chamfer profile.

With only one tool set, they can then machine up to four different profiles or workpieces – without changing tools, which

means without setup time or machine downtime. The setup process on the KFA aggregate is even carried out within the normal workpiece gaps, ensuring high productivity.

The diamond-studded „flexTrim“ and „FK31“ edge cutters for form cutting aggregates from Homag likewise offer a flexible profile selection. The flexTrim tool consists of two cutters with profiles of differing size which are arranged into each other. One of the cutters is set back and can be automatically pushed forward when necessary. It is possible to automatically switch between two radiuses or chamfers within a workpiece gap of 400 mm. In addition to two freely selected profiles, a chamfer under 15 degrees can be installed via the radius outlet.

As an additional option, the FK31 DP edge cutter

enables the machining of up to four different profiles without changing tools. There are three individual cutters which can be designed with differing profiles, according to customer request. Additional chamfer machining is possible via the radius outlet. The profile change occurs within a workpiece gap of 400 mm.

1 CUTTER - 4 PROFILES!

FK31



Steps ahead!



LEUCO solution: Economic efficiency

UP TO 1 MILLION WORKING METERS: NOBILIA BELIEVES IN 70°

LEUCO p-System jointing cutters work around the clock at nobilia

“There is no second place on earth where as many kitchen cupboards are produced each day as in the 2 nobilia sites” Mario Röttgers, head of parts production at nobilia is convinced this statement is true. The LEUCO 70° p-System cutter is part of this success.

nobilia is Europe’s largest kitchen manufacturer, producing 580000 fitted kitchens in 2013. This means they produce over 5.7 million cupboards and more than 1.4 million worktops. 1 in 3 kitchens in Germany come from their assembly line. There is however room for growth regarding export – the quota here is approx. 40%. In this area, the customers’ expectations change more rapidly. Individuality is of great importance. nobilia caters for a wide spectrum of designs – modern and trendy, classic and timeless, Mediterranean and country. 113 different fronts, 45 worktop designs, 16 colours for the unit body, 14 electronic brands and nearly 2000 types of cupboard units round off their portfolio.

DIVERSITY REQUIRES FLEXIBILITY – “p-SYSTEM” IN SERIES PRODUCTION

There are theoretically 280000 different combination possibilities for a nobilia kitchen. This fact can only be reached with highly skilled employees combined with complex yet flexible production processes, that are ef-

ficient and of a high quality standard. nobilia employs more than 2500 people, and both factories in East Westphalia are among the most modern and efficient kitchen manufacturing sites in Europe. And whilst the fronts are individualised – the laser edge has been available for over a year now – the standardised unit production requires endurance characteristics. We are talking about the precise edging of 16 and 19mm thick chipboard, covered with melamine resin impregnated designs – and this in astronomical amounts. Chipping is not acceptable for the discerning customer. The largely automated internal quality control system would recognise such blemishes immediately. A high quality standard coupled with efficient production – this is the place for a LEUCO p-System.

The material processed on the panel sizing saw has a gross mass of 4 to 5 mm. 3 mm is removed by the hogger (dual hogging process with LEUCO PowerTec), and the remaining millimetre is removed using the LEUCO p-System jointing cutter. The “P” stands for peeling – the revolutionary woodworking process where the cutting edge is at a sheer angle of 70°. “Each extra degree of the sheer angle is an advantage for a jointing cutter” so LEUCO and nobilia’s experience shows. A drawing cut is achieved in the material, the material is cleanly removed and there is less strain on the cutting edge. The cutting edge is made of polycrystalline diamond (DP).



Modern production technology and competent staff contribute to the success of Europe’s largest kitchen manufacturer (Jürgen Noll at the control point for the unit body production line).

„With the p-System we have almost no edge-chipping and therefore next to no waste” Mario Röttgers confirms the effectiveness of the new tool generation. Despite different suppliers, the processing of the middle layers is perfect, and materials are well prepared for immediate edging. Milling feed at nobilia is 60 to. 80 m/min.

SUCCESS IS PREDICTABLE – EVEN IN KITCHEN MANUFACTURING

LEUCO presented the p-System to the public in 2010, and since then nobilia has been using the tools in series production. They are among LEUCO’s development partners. LEUCO has created with the p-System an advantage for itself among their competitors, the tools are implemented at both nobilia’s production sites “tool life still hasn’t expired” reports Mario Röttgers, the tools have been in continuous use for years. But the important key factor for the kitchen specialists, is not waiting until the tools need to be changed, but “being able to plan the tool replacement and integrating this into the production process.” In the past asymmetric tools with 3 adjustment paths were in use „We had to adjust



Mario Röttgers (left.), Head of parts production at nobilia, receives a recently sharpened DP cutter from Michael Koch (right.), LEUCO’s regional sales manager (and that’s why they should both be wearing protective gloves!).

the tools 3 times a week, and we couldn't foresee when this was necessary, and it usually had to happen at the wrong time." The head of the part production department recalls. „The tools were blunt after 3 to 4 weeks". With the p-System, tools are exchanged after 10 weeks „in our experience this is a good time to exchange, the tool is still sharp and can be cleaned, re-worked and checked for damage" Following this pattern saves nobilia some unpleasant surprises, "a planned tool change takes 15 minutes less than an emergency change and can be integrated ideally with the maintenance or idle times of the machine."

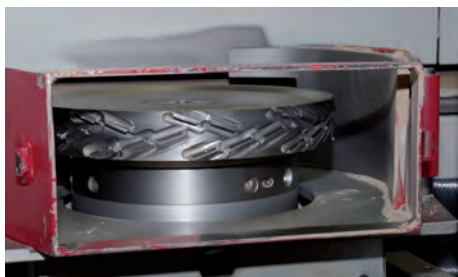

Here you can clearly see the 70° cutting angle of the p-System tool.

In terms of worked metres, the p-System has increased tool life to tenfold that of a conventional milling tool – namely achieving over 1 Million metres. It has proved advantageous to process 16mm and 19mm chipboards with their own individual tool, nobilia has enough machinery and equipment to enable this.

Another effect of this long life: the staff working at the machine only change tools 2 to 3 times a year, this means they can't develop a routine as good. To prevent errors, Röttgers has written step by step instructions, and these can be found with the necessary tools at the. "this saves both time and the hassle of searching and unnecessary questions. In some cases, the set up times were reduced by up to 90%", recalls Röttgers. The down time for tool change and set-up has been reduced to less than 30 minutes.

The reduction of waste to a minimum and shorter set-up times generally lead to an enormous cost reduction. In Mario Röttgers unit body parts department, these 2 criteria have led to a six figure cost reduction. For Mario Röttgers it is clear that the 70° angle p-System jointing cutter is extremely efficient when processing vast amounts of materials.

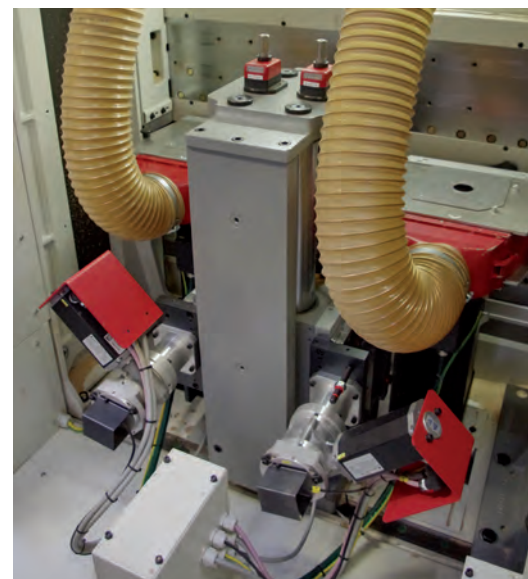

nobilia has 2 p-System cutters in one machine – one for the 16mm. And one for 19mm boards.

Tools on LEUCO p-System basis

„EACH DEGREE OF SHEAR ANGLE COUNTS“

How do you calculate the economic efficiency of a tool? Economic efficiency is defined by profit divided by expenditure. Transferred to tools, profit means edge life and expenditure means the price of the tool.

In order to make a tool economical the edge life performance must be higher in proportion to the surplus price.

How can you calculate the economic efficiency of the LEUCO p-System tools?

You only have to consider the edge life in relation to the tool's shear angle. The edge life of a tool with a shear angle of 55° is twice as long compared to a common shear angle of 35° for instance. The p-System tool with a shear angle of 70° reaches 8 times the edge life. This was documented by the engineers of the LEUCO R&D department.

Why does each degree in shear angle count?

The edge life of tools is clearly increasing with larger shear angles. The cutting edge is exposed to less pressure. This means less wear and longer edge life.

This increase of edge life by itself makes the p-System the most economic tool in the industry segment.

How are resharpener costs of the diamond-tipped LEUCO p-System tools included?

After resharpener, the tools reach the extremely long edge lives once again and additionally increase the profit.



FREE OF CHARGE ...

Apart from the reduction of tool costs and the increase in profit you will receive:

- | free of charge excellent cutting quality,
- | reduced machine downtimes thanks to less tool changes,
- | chip-free quality when cutting on end, new
- | processing possibilities also for difficult materials
- | and much more.



LEUCO solution processing solid woods

HIGH-PERFORMANCE CUTTER HEAD „ULTRA-PROFILER PLUS“

Change cutting knives manually, fast and with highest precision!

The knives on the new high-performance cutterhead „UltraProfiler plus“ from LEUCO are changed manually yet quickly with the highest level of precision. With the innovative cutting insert clamp the knives position themselves on their own without clearance. The user requires a max. of 10 seconds for the change. The blades have a precise and firm seat; the safety of the head is guaranteed. This way the new UltraProfiler plus reaches a cutting speed up to 80 m/s. With its aluminum base frame, the cutterhead is used in

double end tenoners and molding machines as well as in spindle molders and machining centers to shape solid timber and wood materials.

The cutterhead body and mounting plates will be profiled according to customer specifications.

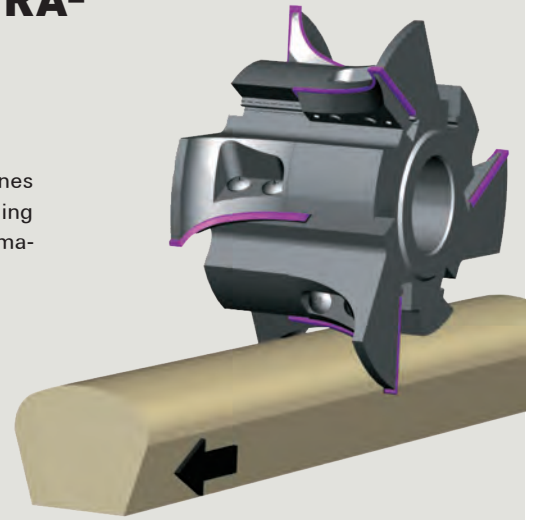

LEUCO solution processing solid woods

PLANING KNIVES WITH „LEUCO TOPCOAT“

Coating for triple edge lives

From middle 2015 on the new LEUCO planing knives will be available optionally coated by „LEUCO Topcoat“ – a quite young but already proven special coating by LEUCO. Probanders were enthused by the triple edge lives compared to uncoated knives. The new „LEUCO TopCoat“ coating effects an anti-adhesion property of the planing knives and avoids unwanted heating.

The coated knives are for use in all common planing cutter heads. Resharpening can easily be done and without any damaging of the

coating. After resharpening the knives reach the triple edge lives again and additionally increase the profit.

Proven Coating

For two years now the „LEUCO TopCoat“ coating wows the branch on fingerjoint cutter by their triple edge lives. The coated jointing cutters are used for jointing softwood, as well as hardwood.

The coating basically prevents wear of the

cutting edge. The LEUCO TopCoat coating will become an integral part of the LEUCO offer for processing solid wood.

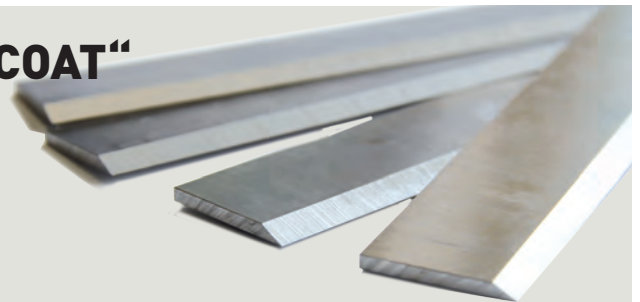

LEUCO solution processing solid woods

TURNERY COPYING SAW BLADE

The new turnery copying saw blade of LEUCO is for use on wood turning lathes with saw unit and for manufacturing baluster in hard and softwood. The saw blade is perfectly suitable for processing deep profiles, as well as tear free and splinter-proof turned parts and vibration-free working.

This turnery copying saw blade is adapted for woodturning-milling and also for mill-

ing squares or chamfering.

The twopart sawblade is screwed together, HW tipped and has a specific tooth geometry. LEUCO offers the saw blade with a diameter of 350 mm and number of teeth is 90.



NEW
IN THE
CATALOG

LEUCO Solution

MODULAR KIT SYSTEM WITH SLIDING COVER FOR QUICK TOOL CHANGE

LEUCO dusthood for flooring production lines

The interaction of tool and dusthood is essential for chip removal and effective processing. The hood must be easy to mount for the machine operator, so that worn parts and tools can be quickly and easily exchanged.

LEUCO modular kit-system

The cutting speed in a flooring production line, and therefore the chipping speed, is between 60 and 100m/s and thus a multiple of the suction speed. This means that the chip removal is a vital element of the suction hood. The basic shape ensures an air supply which is free of turbulence and provides a favorable flow rate. This also leads to a lower energy consumption of the dust extraction system.

Contact between chips and hood, is however inevitable. Therefore it is important that the contact points be defined – i.e. that contact occurs at pre-determined locations. The LEUCO hood includes special wear plates for this, which have a stable design. These are open to wear and tear – especially when abrasive materials are being processed, such as in the case of laminate flooring. Due to the modular design of the hood, these parts can be easily and cost-effectively replaced, without having to replace an entire dusthood.

To optimize chip-extraction, the dusthood has to be adapted to the machine base.

Ewald Westfal, Head of Technology at LEUCO, shows the externally visible hood details: Adjustable plates on the hood cover for regulating the air supply and sealing up to the hood, sliding covers with snap mechanisms, the adjustable wear plates



LEUCO achieves this by simply using a special process to adapt the replaceable wear plates to the machine base. The CAD-based design and documentation guarantee easy and quick replacement of these wear plates. „The differing tool angles necessary to produce a Click/Lock profile – whether jointing or hogging – require only a slight adjustment to hood parts, making the system quickly compatible for all processes,” emphasizes Ewald Westfal. As Head of Technology, he manages the Research & Development, Application Technology and Design departments at LEUCO and thus combines their special knowledge to achieve precisely such customer-oriented solutions as the modular hood.

Measures not visible from the outside round-off this sophisticated system. So-called “C-plates” are in place to seal off chip flow towards the machine. A further chip guidance rail conveys circulating chips to a second level, thus avoiding double chipping.

A particular advantage of this modular system is the adjustability of the components.

The base hood and any of the wear plates can be individually positioned and optimally adjusted to the given conditions.

To simplify daily use with the dusthood, the sliding cover can be positioned with a snap-mechanism. Adjustments of 2-piece toolsets to new positions or widths, or the replacement of tools can be carried out quickly and easily. Thanks to the easily retracted and extended sliding cover, not even a tool change

poses any problems.

Additional adjustment plates on the cover of the hood close the opening between the hood and the machine base, vital when processing is carried out at an angle. After taking all necessary “seals” in the machines direction into account, the air supply should not be forgotten. The suction only works if air can also be extracted. For this reason, an adjustable air supply is in a central position above the spindle, which provides the entire system with the amount of air required.

Product Manager Paul Götz takes a look at the complete production process of a Click/Lock profile and summarizes: “The modular dusthood system has been optimised after years of research. Due to the numerous possible combinations, the system can be installed at all processing stages, quickly and easily.”

Concept layout: The modular kit system dusthood system guarantees flexibility in laminate floor production, is simple to use and optimises the energy requirements

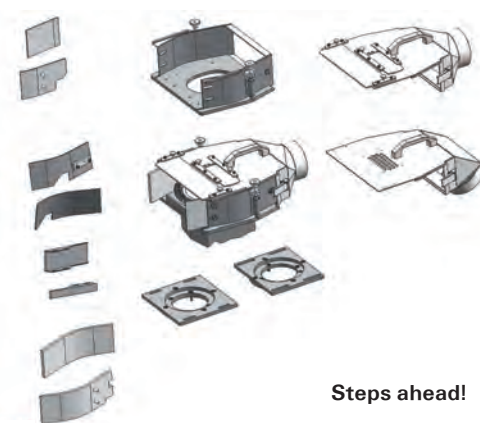

At LEUCO a computer simulation is used to calculate the basic form of the hood in terms of air circulation

“The modular design of the LEUCO dusthood ensures flexible usage, extremely easy handling and optimized energy use for laminate flooring production,” states Ewald Westfal, Head of Technology at LEUCO (left) and Paul Götz, LEUCO’s Production Manager for Flooring (right)





A PICK-UP DRIVER? WE HAVE 7500 OF THEM!

Tool collection from the customer via a parcel service

I ALWAYS HAVE TO
RELY ON THE DRIVER
FOR THE SHARPENING-
SERVICE.
JUST ONE? WE HAVE
7500 DRIVERS!



The new customer service offer from LEUCO which started in 2013, has proven to be very much in demand. Dull tools can be put in a specially designed service box, and are then collected by a parcel service.

How does the sharpening service via service box and parcel service work?

The LEUCO sales representative explained the process in detail at the company Wössner, and left a service box with them. The production manager can call a special LEUCO

CO hotline to request the sharpening of dull tools when necessary. Within 48 hours the service box will be collected at the customer and delivered direct to a designated LEUCO tool sharpening centre. After the re-sharpening has been carried out to manufacture standard, the service box is returned to the customer within 9 days.

What do the service boxes look like?

The specially designed LEUCO services boxes are made of plastic and are available in 2 different sizes. Up to 13 saw blades

can be transported in these robust boxes from the customer's production site to the next designated sharpening centre. The maximum diameter of 450 mm applies for these boxes.

Advantages of this service

With this service concept, LEUCO offers its customers complete control as to when dull tools are collected, sharpened to manufacturer standard and returned. This allows the customer a high level of flexibility.

The parcel service is ideally suited to...

Small and medium size businesses in the wood and furniture industry with normal to increased and/or irregular sharpening cycles.

For more information on the LEUCO service box, the LEUCO sales department and representatives are willing to help.

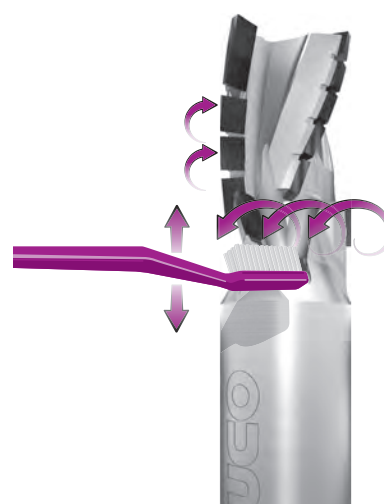
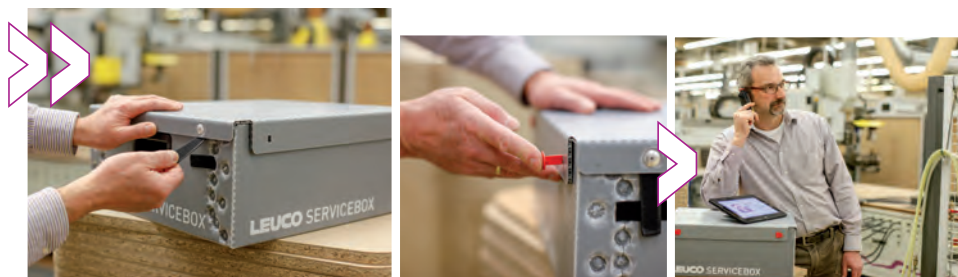

Good ideas need good solutions.

LEUCO as tool supplier at nobilia

SERVICE METER FOR METER

LEUCO delivers more than "just" the tools for nobilia

Mario Röttgers (Head of parts production at nobilia), Ralf Richter (Head of tool management at nobilia) and Michael Koch (Regional sales manager at LEUCO) discuss the introduction of the p-System and the leasing of precision tools in the kitchen manufacturing industry.

Delivering tools of a high quality just isn't enough these days. In order to remain attractive for the furniture manufacturing industry, the tool manufacturers are extending their range of service to consist of integrated system components and service. The complete package differs according to the size of the company, and naturally according to the customers' demands. For the past 12 years, the East Westphalian kitchen manufacturer nobilia has relied on the leasing and service provision by LEUCO, the tool manufacturer from Horb am Neckar. The last new LEUCO introduction to the corpus production line at Europe's largest kitchen manufacturer was the "p-System" and the "PowerTec III" hogger.

Mario Röttgers (MR): We don't really notice the people from LEUCO here at the corpus production line....

Michael Koch (MK): ... although they are here at least 2 or 3 times a week...

Ralf Richter (RR): ... and refill the tool supply cupboard!

MR: That's exactly what I mean - it simply works! LEUCO delivers the tools on time and exactly to where they are needed: in the consignment stock cupboards at the production lines at both of our production sites. Our technicians immediately have the required tools at hand when needed or at a regular maintenance interval.

MK: According to the metres processed, we

can work out the tool requirements. The customer pays the tariff "jointing per metre". We provide the necessary tools for the corpus production line - whether p-System jointing cutters, PowerTec III, grooving cutters or edge-banding tools.

RR: We have been using the 70° p-System tool since 2011.

MR: Internal testing was very successful, so we reacted and converted to the p-System - and this conversion was large-scale. As one of the leading kitchen manufacturers, we need such innovative solutions in order to compete on the market.

MK: The introduction of the P-system wasn't of course just a systematic replacement of existing tools; it was an optimisation of the entire corpus production line for the use of the PowerTec and p-System.

RR: Both tools are used for processing 16mm and 19mm melamine resin covered chipboards. A gross mass of 4' to 5mm is removed by the panel sizing saw-blades, 3' by the hogger and the last mm the jointing cutter. The p-System sheer angle of 70° provides a drawing cut in the material. The material is literally "peeled" off and the cutting edge remains sharp. A 1.2 mm thick PP-edge (Polypropylene) is the decorative and protective finish. A clean finished joint is not only an optical criteria: a good fitting of the edge is essential in protection against moisture, which is of course vital for kitchen furniture

MK: The cutting edges are made from Polycrystalline Diamond (DP).

MR: We produce over 25,000 cabinets per day at both our production sites - and this is on the increase. We hold a strong position on the German market and are expanding on the export market. Our demanding customers do not tolerate edge chipping. With the p-System there are as good as no damages to the edges or finish - and therefore less waste.

RR: We must also say that the LEUCO p-System tools have a longer life. -we have calculated that the tools can run 1 million metres. Of course we don't push this to the limit - we change the tools at regular, but long intervals. We also physically need less tools - one set



Approximately 16,200 cupboards are produced on a daily basis at nobilia site 1, and approximately 11,000 are produced at nobilia site 2. Both sites use LEUCO P-System and PowerTecIII.

on the machine, and one which is re-sharpened and then back on stock. When we used to change the tools on a weekly basis, there were always tools "lying around" somewhere - whether at the production line, being sharpened, or on stock. The p-System therefore also provides financial advantages. Our logistic department would have problems staying up to date if it wasn't for the LEUCO leasing and service package. We would need more employees just for tool management; the co-operation with LEUCO helps us in this area too.

MK: LEUCO agrees in the contract to provide a constant stock of tools for nobilia.

MR: Part of this agreement is also to provide the latest tool innovations. Together we test the efficiency and quality they can provide in our production process.

RR: LEUCO tools have to meet the high standards we set. They must be able to cope with our high production levels, meet a high quality standard and fit in effortlessly with our production processes. Due to the long-standing and good co-operation with LEUCO, we have developed and optimised new tools and processes together.



The tool cupboards in the middle of the production building are kept up to date by LEUCO employees. (Mario Röttgers head of parts production dept. checks the tools on stock).



Mario Röttgers (MR); nobilia

Ralf Richter (RR); nobilia

Michael Koch (MK); LEUCO



iBlade – the tool intelligence

TRANSPARENCY AND COST CONTROL

Thanks to the „iBlade“, LEUCO offers their customers a system for tool data tracking

Where is the tool-card? When did I buy the tool? How much did I pay for it? How often has it been serviced so far? Is it worth while buying such a tool again? These are questions which arise as soon as a tool has to be replaced and costs and benefit have to be considered.

Tool data management „iBlade®“

The whole system consists of a RFID-Chip (Radio-Frequency Identification) which is attached to the tool, an iBlade® data reading pen and the iBlade® software. The chip allows to save more than 30 service cycles as well as other information. It can be attached

to almost every tool. The existing tool inventory and new tools can easily be equipped. The chip is resistant to interferences such as magnetic fields, ultrasound, temperatures of up to 150° etc.

The „iBlade® Reader“, a scanner and writing pen, reads and writes the data with a distance of max. 3 mm to the chip.

Overview of tool inventory

As soon as all data is in the system you only need two mouse clicks in the tool management program to find out which tools are in operation, in service or in the storeroom. The iBlade® allows new concepts in the



With the new „RFID-System iBlade“ LEUCO provides its customers with a system, where data stored on the chip in the tool can easily be transferred to a PC and then processed using the i-Blade software, whether as protocols, analysis, or use and production flow optimisation.

woodworking and furniture sector, whether with through-feed and stationary processing or sawing no matter if it is an industrial enterprise or a craftsman's workshop. The decisive factor is the wish for tool transparency.

Vision by LEUCO „Industry 4.0“

TOOL-CLOUD Digital Résumé for Cutters and Co.



Everywhere we look, information technology is increasingly finding its way into our lives and is certainly already a part of our daily lives. The trend to digitizing everything that can be digitized is unmistakable. Digitization will completely transform every market and our everyday lives as well. Because what distinguishes the megatrend of digitization is new business models or „overnight if necessary“ approaches. Old processes are collapsing because of, for example, revolutionary new apps or big data. This so-called fourth revolution (Industry 4.0) is now increasingly the pacesetter in the woodworking and furniture industry, as well, but that's not the only reason it is one of the central themes at LIGNA 2015.

UlIn order to always be able to ensure optimal

utilization of precision tools here, the current operating parameters need to be set precisely after each use. Up to now, they have been recorded by hand on a tool card, a costly process. This is where there is enormous potential for optimization in terms of expenditure of time and money, susceptibility to error inherent in manual processes, production of rejects, loss of tool cards, restricted overview of current tool inventory and condition, just to name a few of the issues.

ToolCloud-Project:

The digital tool card is currently being developed in a joint project in order to create standard solutions for the weak points described above.

Participating in this in addition to LEUCO, are companies in the field of machine engineering, one IT company and one standardization organization, as well as the University of Munich.

The goal is to use unambiguous marking and identification to develop cross-company lifecycle management for tools. Then the digital tool card will float, so to speak, over the supply chain in a so-called „trusted cloud“. As a result, data can be retrieved across companies and locations and automatically transferred to machines, as well as kept up to date at all times. These digital machine-tool interfaces result in a smooth „plug & play“, i.e. in using and seamlessly starting the operation.

Technology symposium at LEUCO

“INNOVATION MEETS EMISSION”

Approaches, perspectives and solutions

“LEUCO places great importance on holding this technology symposium with a theme that is so significant in our sector – even more so in connection with our 60th anniversary celebrations” were the words spoken by Frank Diez in his welcoming speech. More than 80 experts from the woodworking, furniture and machine manufacturing industry from Germany and neighbouring countries, came to Horb am Neckar at the end of October.

Moderator Dieter Rezbach, a renowned expert in the sector, stated in his opening speech “At LEUCO it is common practice to not just hear, but to listen – to understand the needs of the customer and to translate these needs into appropriate solutions” There is currently a lot of competitive pressure on the market, both in Germany and internationally. And this situation provides the best framework for innovation.

Prof. Rolf Staiger from the University of Rosenheim prepared the ground for the following lectures perfectly with his complete overview. He appealed for the best possible use of the resources available to us.

Manuel Kreutz from the Cologne based Smarte Energie, showed on hand several striking examples, just how important intelligent technology is. On the whole, an intelligent use of energy contributes a great deal to a company’s competitiveness.

Peter Martin, technical director of Weinig profile machines, showed how machine manufacturer Weinig (Tauberbischofsheim) approaches the theme efficiency and emission right at the start of the process chain. Using clever machine and tool concepts, machining time is first reduced and then optimised.

The R & D directors Dr. Dominique Fendeleur and Ewald Westfal both stressed that LEUCO can additionally be seen as an international trendsetter regarding emission and not just regarding processing quality and efficiency. LEUCO didn’t wait until this topic became a trend. Tooling systems such as the i-System and p-System, special extraction hood constructions and NoNoise saw blades are synonyms for this topic.

USING CLEVER MACHINE AND TOOL CONCEPTS, MACHINING TIME IS FIRST REDUCED AND THEN OPTIMISED.

Quote Peter Martin, Weinig

energy efficient and resource reducing production. Shortened set-up times, increased production frequency and maximum machine use contribute to sustainable results.

Homag has been active in resource reducing production since 2007. In 2009 the name ecoPlus was introduced at Homag and has been a constant ever since. By the time the LIGNA came around in 2011, there were more than 100 defined measures under the heading sustainability – all Homag machines are available with ecoPlus, explained marketing director Alexander Prokisch.

And finally Sascha Schöpf from Walter Knoll presented the furniture producers approach to this topic. He showed us in an entertaining way how the circle of sustainability is closed by their customers.

In summary: Emissions are not a one-off subject. There is also not just one general solution for all businesses.

Between presentations, the guests could convince themselves about the meaning of „Low Noise“ saw blades for a comfortable working environment.



Exciting speeches from renowned speakers: f.l.t.r.: Rolf Staiger (Hochschule Rosenheim), Alexander Prokisch (Homag), Dieter Rezbach (Lignum Consulting), Ewald Westfal (LEUCO), Peter Martin (Weinig), Dr. Dominique Fendeleur (LEUCO), Sascha Schöpf (Walter Knoll) together with the General Managers of LEUCO and hosts of the symposium Frank Diez (above left) and Daniel Schrenk (above right), not on the picture: Manuel Kreutz (Smarte Energie), André Strunk (IMA)



All guests agreed that the well-organised symposium at LEUCO on this topic provided an insight into the connections and interactions in all areas regarding emission. Constant development provides success for the company, the sector, society. Awareness for this topic has been awoken; our eyes are peeled for viable, innovative solutions.



Jubilee!

10 YEARS LEUCO RUS GMBH!

Always looking forwards with the aim of making our customers successful!



LEUCO RUS GmbH, based in Moscow, is celebrating its 10th anniversary. In 2005 it was not only the first LEUCO subsidiary in this region but also offered the first service center to provide the countries of the former Soviet Union with a local sharpening service.

It was and remains important for LEUCO to be directly represented in its key markets and give responsibility to local management teams in order to understand the culture, markets and customer needs better.

Irrespective of all crises and sanctions, LEUCO RUS has permanently developed further in accordance with the growing market requirements. With branches in St Petersburg (North

West region) and Stavropol (South region), the company once again underlines that a local presence is also embodied in actual practice. With a sales office and service station in each region, the company is always available for its customers here.

To offer the best support for its customers in the Russian market, LEUCO is developing its success factors namely man and technology. It is particularly well qualified and motivated personnel who are responsible for the continuous optimization of the sites. Further training, therefore, has the foremost priority not least through the active exchange on the latest machine and tool technology with the parent company's



...and the colleagues from Stavropol.

LEUCO Academy. Employees of LEUCO Research and Application Technology regularly visit and advise customers together with the local LEUCO colleagues.

LEUCO RUS will give priority to the development of the service center in the future and ensure the fast availability of diamond tipped precision tools.

The LEUCO RUS managers are sure, "We can only secure our opportunities as a precision tool manufacturer if we succeed in supporting our customers and making them successful."

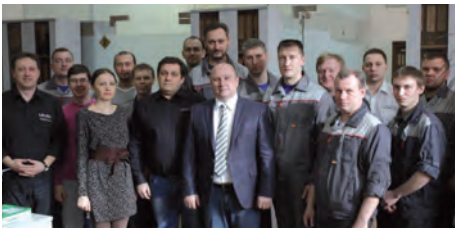

10 years of LEUCO in Russia: Staff of LEUCO RUS is sending greetings to the "LEUCOline"! above left – colleagues from Moscow together with the General Manager Konstantin Kunstman (at the front, in the middle), above right greetings from St. Petersburg...

NEW: LEUCO ONLINE-CATALOGUE

Tools easily found!

The new LEUCO online catalog with many concrete search and filter options!

The new LEUCO online catalog is called „Tool Finder“ and makes searching and finding of woodworking tools for the entire wood and furniture industry really simple as from now.

Users can choose from six options to select a tool:

- | Select the material to be processed with a suitable tool (e.g. MDF)
- | Specify the machine on which the tool is to be used (for example, through-feed machine)
- | Indicate characteristics the desired tool should possess (e. g. diameter)
- | Define the tool by its type (e.g. drills)
- | LEUCO product name (for example LEUCO p-System)
- | Or directly enter the LEUCO ident number of the tool



Test the ease of use under www.leuco.com!

You are not looking for anything specific, but simply want to browse only in the LEUCO tool program? You get simple access through the function „Browse the Catalogue“.

Good ideas need good solutions.

LEUCO TOOL CORPORATION ANNOUNCES A NEW LOCATION NOW OPEN IN MISSISSAUGA, ONTARIO

LEUCO is excited to highlight its commitment to reliability and innovation directly in Canada. The New facility is operational for direct sales and servicing of precision tools. LEUCO's Location is strategically located at 6295 Shawson Drive Unit 9 In Mississauga. This Central location offers easy access for local and expedited logistics. LEUCO has been selling in Canada for well over 20 Years with great success. This will be their 6th Facility within their US division. CEO, Jens Schulz stated, "We are very excited to offer this direct sales and service facility to better support our customers needs."



Statement

INNOVATIONS OF THE FUTURE

Already Winston Churchill said, **“To improve is to change; to be perfect is to change often.”**

The requirements for us, as precision tool manufacturer, are diverse. Technical expertise, networked thinking as well as creativity are the guarantee of the countless product innovations of LEUCO – and this right from the outset!

If you look at the product innovations which LEUCO has launched on the market as system partner and supplier of the wood and furniture industry, it can be seen that there are essentially four basic principles in almost all innovations.

INNOVATIONS...

- | for the improvement of the look, feel and longevity of semi manufactured products and furniture parts.
- | for the improvement of the work environment in modern productions.
- | for flexibilization in manufacturing applications
- | Product innovations for a performance increase in the wood and furniture industry.

In the area of **innovations for the improvement of look, feel and longevity**, the zero joint technology of edging application by means of laser, hot air and similar procedures can be named. LEUCO as tool manufacturer has here understood – not least through the LEUCO p-System – to provide the right tool solutions for the market in format processing as well as for edge reworking.

In **work environment improvements**, noise optimized LEUCO tools such as LowNoise joint systems and NoNoise saw blades, chip flow optimized chip master tools and Aerotech technology were able to establish themselves on the market. There is also increasing demand for power consumption data of the tools, not only because of the motor orientation but also to save resources. Our customers in the furniture industry also want to

use **flexible tool systems in production** in order to minimize, particularly in batch size 1 manufacturing, machine standstills due to setting up, setting and tool change times. For this we have developed tool systems with which various profiles, coatings, groove widths and edges may be processed without any changes. These challenges will remain a focus of our work also in the future.

In a global competitive environment, **innovations for a performance increase** have lost none of their significance. For us, the adjusting screws here represent the further development of geometry, cutting materials and manufacturing methods.

Until now, it involved interesting developments in specific tools, machines and materials. **Now the potential and leverage of digital processes as well as intelligently networked organizations is increasingly being seen, also in our industry.**

To summarize, it may be said that for all the named innovative trends, a functioning interplay between customer, machine and tool manufacturer but also (wood) material manufacturer, hardware manufacturer and edge supplier will be more important in the future to **successfully meet the challenge “Innovations of the future”.**

Since January 2014, **Daniel Schrenk has been CEO for Sales and Marketing of the Ledermann GmbH & Co. KG**

About LEUCO

THAT'S LEUCO

**Innovative, trend-setting and reliable
- right from the beginning!**

The company Ledermann & Co. was founded in 1954 by Willi Ledermann and Josef Störzer in Horb am Neckar / Germany. The LEUCO brand was born.

Today, almost 60 years later, LEUCO is one of the world's largest suppliers of carbide and diamond-tipped machine tools for wood and plastic processing.

Wealth of ideas and technical know-how have been the heart of LEUCO since the beginning. The product range includes circular saw blades, hogsers, bore-type and shank-type

cutters, drills, clamping systems and inserts. Sharpening service, application consulting and service packages bundled under the term „Tool management“ complete the spectrum. LEUCO sells via direct sales. Our customers are sawmills, building-, furniture- and paneling-industry as well as interior finishing. Internationally, around 1,100 employees work for LEUCO.

Sales affiliates are in Australia, Belgium, England, Japan, Poland, Singapore, Thailand, Ukraine and Belarus. Sales and production subsidiaries are in China, France, Malaysia, Russia, South Africa, Switzerland and USA.

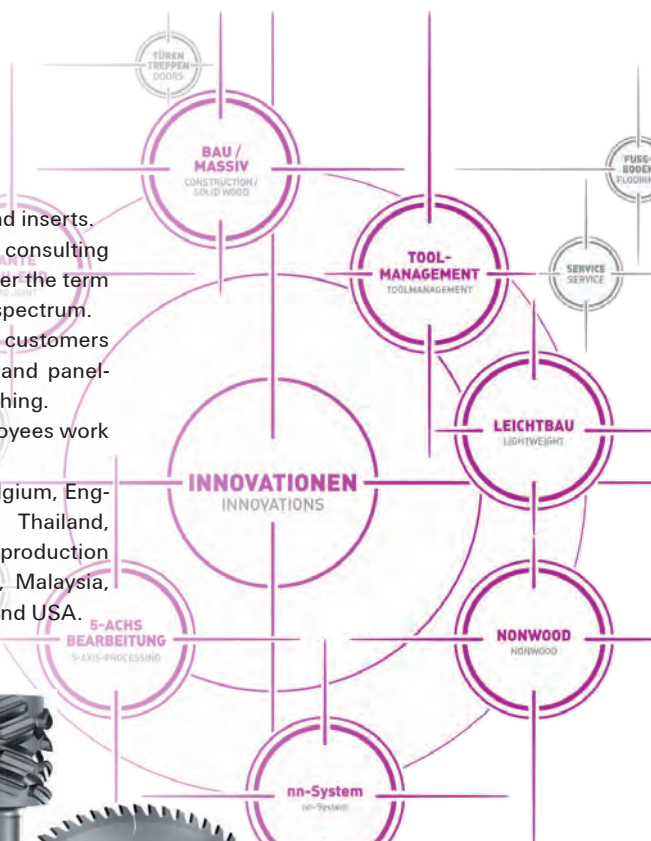

Steps ahead!

Editorial:

Ledermann GmbH & Co. KG

Willi-Ledermann-Straße 1

D-72160 Horb am Neckar

T +49 (0) 7451 / 93 0

F +49 (0) 7451 / 93 270

info@leuco.com

www.leuco.com



LEUCO ONLINE-SERVICE



www.leuco.com



LEUCO Catalog



LEUCO YouTube

